

TA31QR

series

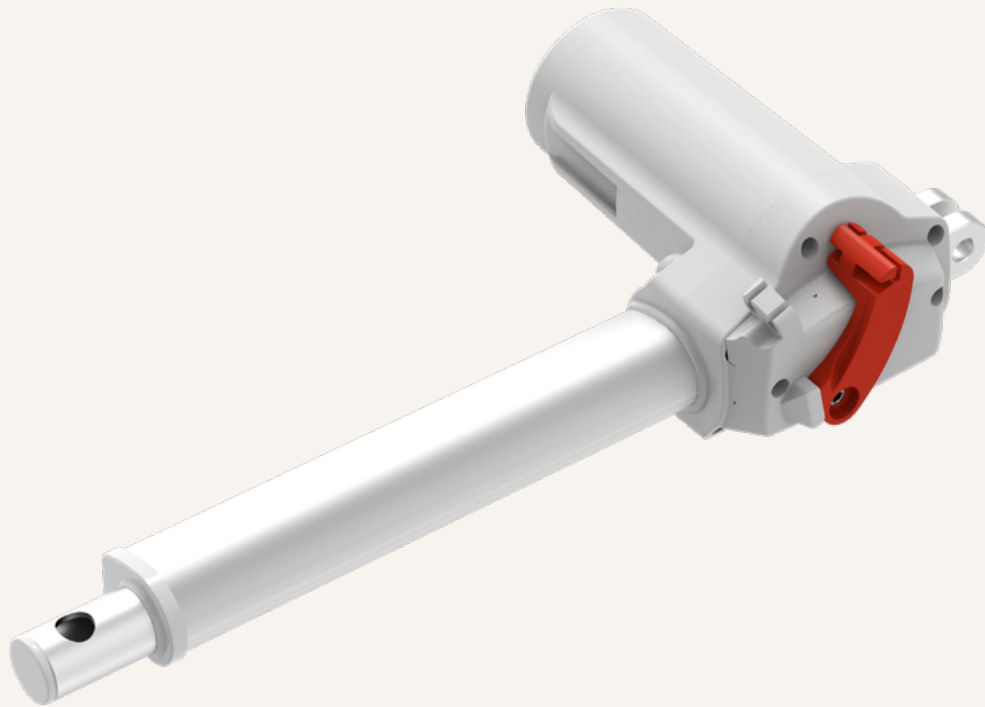

Product Segments

- **Care Motion**

The TA31QR improves upon the TA31 with added design benefits and functionality, while providing a high quality yet economical option for medical applications. In particular, the TA31QR provides multiple output signal options. These include a spindle set Hall sensors or POT which will continue to send position feedback after the quick release action is performed. This feature allows the user to maintain accurate position within the control system without having to perform a system reset.

General Features

Max. load	5,000N (push) 3,000N (pull)
Max. speed at max. load	4.9mm/s
Max. speed at no load	11.2mm/s
Retracted length	≥ Stroke + 178mm
IP rating	IP66W
Stroke	25~450mm
Output signals	Hall sensors, POT, spindle set Hall sensors
Options	Multiple functions for spindle sub-assembly
Voltage	12/24V DC, 12/24V DC (PTC)
Color	Black or grey
Operational temperature range	+5°C~+45°C

Drawing

Standard Dimensions
(mm)

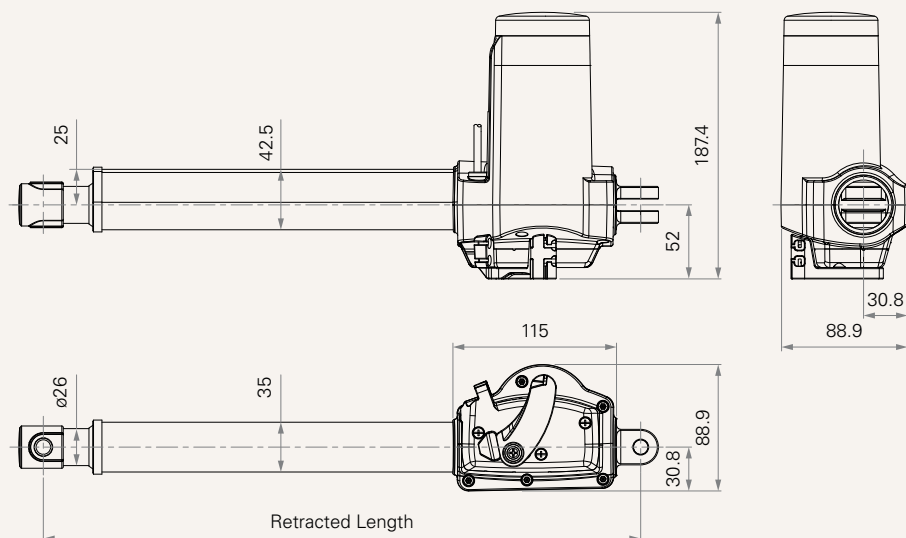

Load and Speed

CODE	Load (N)		Self Locking Force (N)	Typical Current (A)		Typical Speed (mm/s)	
	Push	Pull		No Load 32V DC	With Load 24V DC	No Load 32V DC	With Load 24V DC
Motor Speed (3800RPM, Duty Cycle 10%)							
J	3500	3000	3500	0.8	3.4	11.2	6.9
K	5000	3000	5000	0.8	3.7	8.6	4.9

Note

- 1 The current & speed in table are tested with 24V DC motor. With a 12V DC motor, the current is approximately twice the current measured in 24V DC; speed will be similar for both voltages.
- 2 This self-locking force level is reached only when a short circuit is applied on the terminals of the motor. All the TiMOTION control boxes have this feature built-in.
- 3 The current & speed in table are tested when the actuator is extending under push load.

Performance Data (24V DC Motor)

Motor Speed (3800RPM, Duty Cycle 10%)

Speed vs. Load

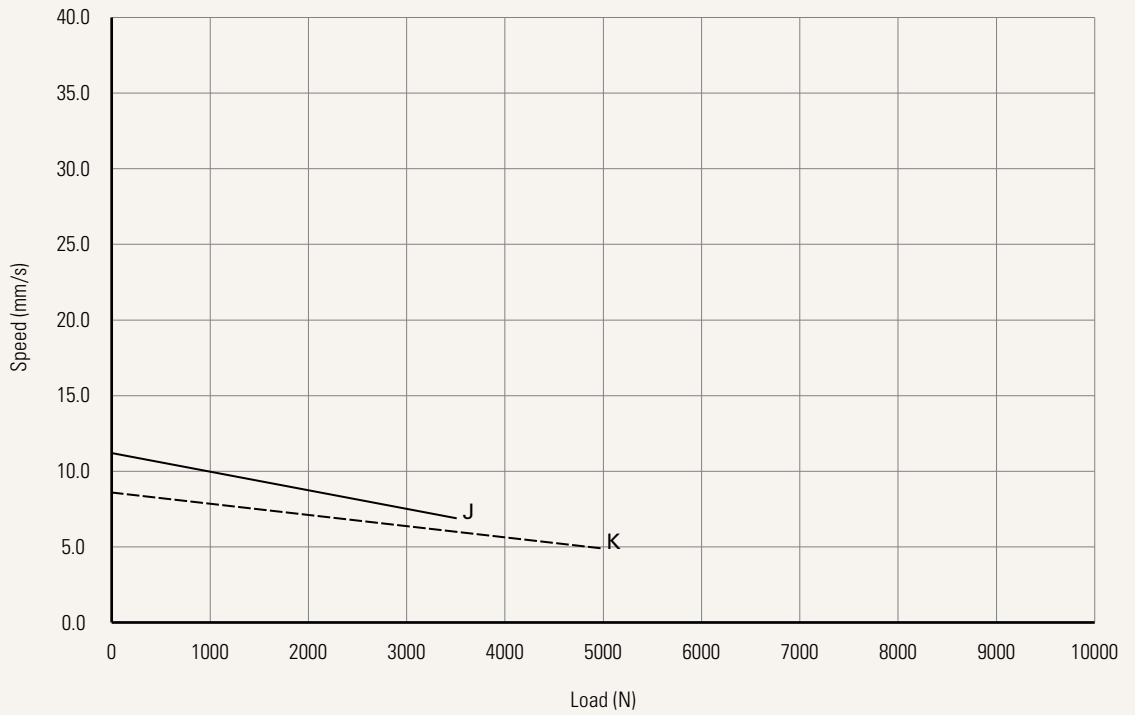

Current vs. Load

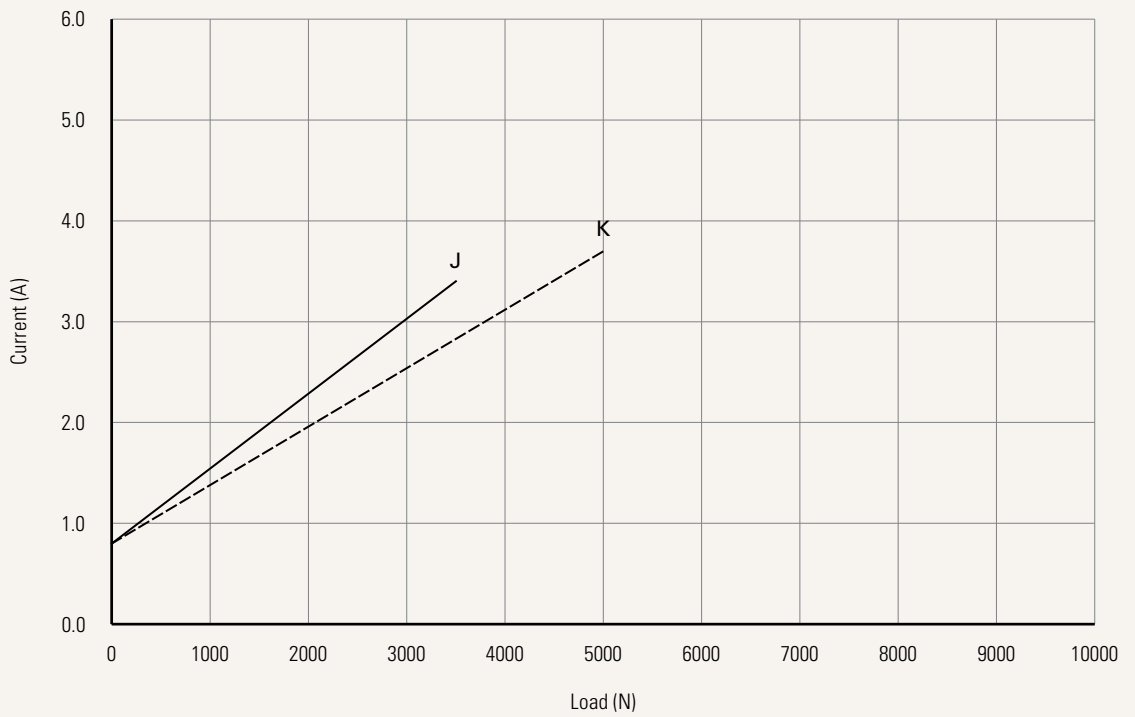

Note

1 The performance data in the curve charts shows theoretical value.

Voltage	1 = 12V DC	2 = 24V DC	5 = 24V DC, PTC	6 = 12V DC, PTC
Load and Speed	See page 2			
Stroke (mm)	See page 5			
Retracted Length (mm)	See page 5			
Rear Attachment (mm)	2 = Aluminum casting, U clevis, slot 8.2, depth 17.0, hole 10.2 3 = Aluminum casting, U clevis, slot 8.2, depth 17.0, hole 12.2 C = Aluminum casting, U clevis, slot 8.2, depth 17.0, hole 10.2, with T-bushing See page 6			
Front Attachment (mm)	1 = Punched hole on inner tube + plastic cap, without slot, hole 10.2, with plastic bush 2 = Punched hole on inner tube + plastic cap, without slot, hole 12.2 3 = Plastic, U clevis, width 8.2, depth 20.0, hole 10.2, for push < 4000N and pull < 2500N 4 = Plastic, U clevis, width 8.2, depth 20.0, hole 12.2, for push < 4000N and pull < 2500N 5 = Punched hole on inner tube, without slot, hole 10.2, with plastic bush 6 = Punched hole on inner tube, without slot, hole 12.2 7 = Aluminum casting, U clevis, width 6.2, depth 17.0, hole 10.2 8 = Aluminum casting, U clevis, width 6.2, depth 17.0, hole 12.2 9 = Aluminum casting, U clevis, width 6.2, depth 17.0, hole 10.2, with T-bushing See page 6			
Direction of Rear Attachment (Counterclockwise)	1 = 0°	3 = 90°		
	See page 7			
Color	1 = Black	2 = Pantone 428C		
IP Rating	1 = Without	2 = IP54	3 = IP66	5 = IP66W
Special Functions for Spindle Sub-Assembly	0 = Without (Standard) 1 = Safety nut 2 = Standard push only		3 = Standard push only + Safety nut B = Cushion	
Functions for Limit Switches	1 = Two switches at full retracted / extended positions to cut current 2 = Two switches at full retracted / extended positions to cut current + third one in between to send signal 3 = Two switches at full retracted / extended positions to send signal 4 = Two switches at full retracted / extended positions to send signal + third one in between to send signal 5 = Two switches at full retracted / extended positions to send signal (Operate with control box: TC1, TC8, TC10, TC14, TC21) See page 7			
Output Signals	0 = Without 2 = Hall sensor * 2		P = POT H = Spindle set Hall sensors * 2	
Connector (mm)	1 = DIN 6P, 90° plug 2 = Tinned leads 4 = Big 01P, plug C = Y cable (direct cut, water proof, anti-pull) D = Extension cable, not preset on motor cover (cable length 120) See page 7-8		R = Extension cable, preset on motor cover (cable length 50) E = Molex 8P, plug F = DIN 6P, 180° plug G = Audio plug Q = Molex 6P, 90° plug	
Cable Length (mm)	0 = Straight, 100 1 = Straight, 500 2 = Straight, 750 3 = Straight, 1000 4 = Straight, 1250	5 = Straight, 1500 6 = Straight, 2000 7 = Curly, 200 8 = Curly, 400 B-H = For direct cut system See page 7	J = Extension cable, not preset on motor cover (cable length 120) R = Extension cable, preset on motor cover (cable length 50)	

Retracted Length (mm)

1. Calculate $A+B+C+D = Y$
 2. Retracted length needs to \geq Stroke + Y
- *Standard stroke: 25~450mm

A. Front Attachment

CODE

1, 2, 5, 6	+178
3, 4	+201
7, 8, 9	+193

B. Load V.S. Stroke

Stroke (mm)	Load (N)	
	3500	5000
25~150	-	-
151~200	-	-
201~250	-	-
251~300	-	-
301~350	+5	+5
351~400	+10	+10
401~450	+15	+15

C. Load V.S. Special Functions for Spindle Sub-Assembly

CODE	Load (N)	
	3500	5000
0	-	-
1	-	-
2	-	+3
3	-	+3
B	+28	-

D. Signal Outputs

CODE	
0	-
2	-
P	+7
H	-

Rear Attachment (mm)

2 = Aluminum casting, U clevis, slot 8.2, depth 17.0, hole 10.2

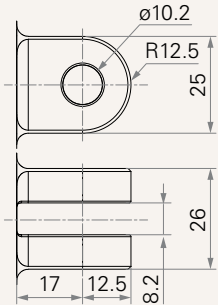

3 = Aluminum casting, U clevis, slot 8.2, depth 17.0, hole 12.2

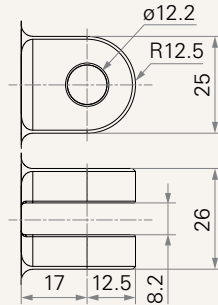

C = Aluminum casting, U clevis, slot 8.2, depth 17.0, hole 10.2, with T-bushing

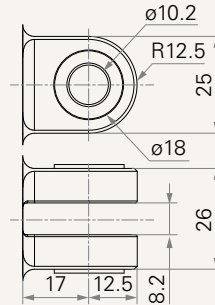

Front Attachment (mm)

1 = Punched hole on inner tube + plastic cap, without slot, hole 10.2, with plastic bush

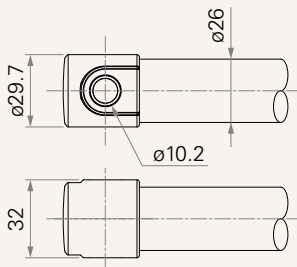

2 = Punched hole on inner tube + plastic cap, without slot, hole 12.2

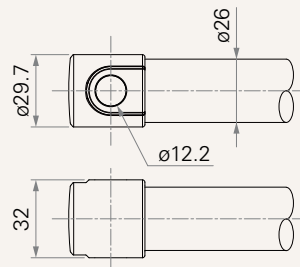

3 = Plastic, U clevis, width 8.2, depth 20.0, hole 10.2, for push < 4000N and pull < 2500N

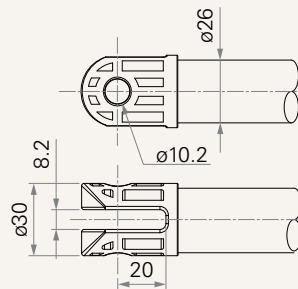

4 = Plastic, U clevis, width 8.2, depth 20.0, hole 12.2, for push < 4000N and pull < 2500N

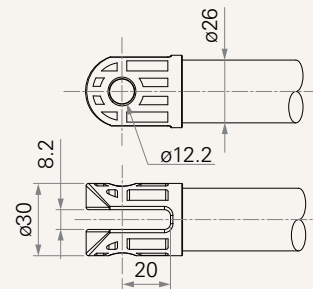

5 = Punched hole on inner tube, without slot, hole 10.2, with plastic bush

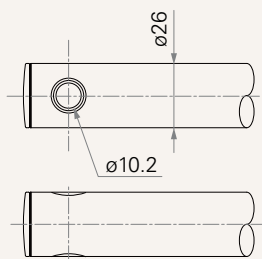

6 = Punched hole on inner tube, without slot, hole 12.2

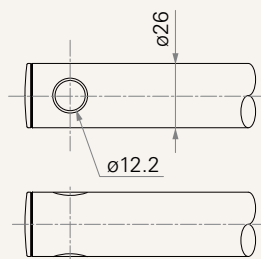

7 = Aluminum casting, U clevis, width 6.2, depth 17.0, hole 10.2

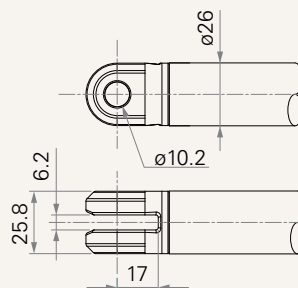

8 = Aluminum casting, U clevis, width 6.2, depth 17.0, hole 12.2

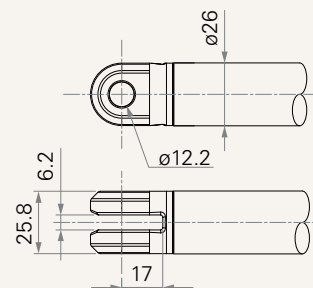

9 = Aluminum casting, U clevis, width 6.2, depth 17.0, hole 10.2, with T-bushing

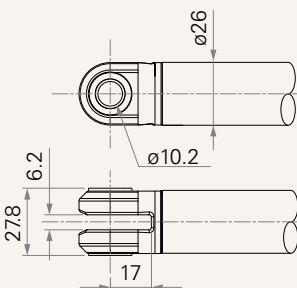

Direction of Rear Attachment (Counterclockwise)

1 = 0°

3 = 90°

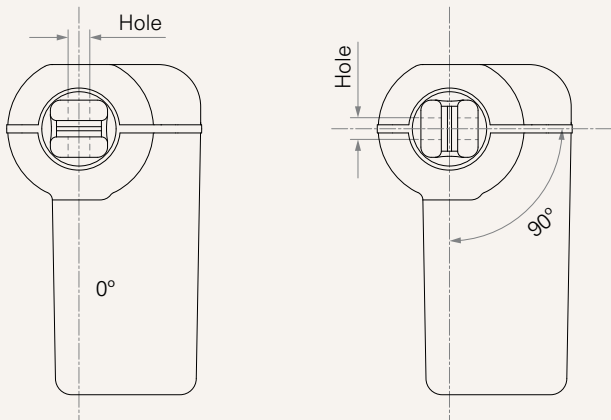

Functions for Limit Switches

Wire Definitions

CODE	Pin					
	● 1 (Green)	● 2 (Red)	○ 3 (White)	● 4 (Black)	● 5 (Yellow)	● 6 (Blue)
1	extend (VDC+)	N/A	N/A	N/A	retract (VDC+)	N/A
2	extend (VDC+)	N/A	middle switch pin B	middle switch pin A	retract (VDC+)	N/A
3	extend (VDC+)	common	upper limit switch	N/A	retract (VDC+)	lower limit switch
4	extend (VDC+)	common	upper limit switch	medium limit switch	retract (VDC+)	lower limit switch
5	extend (VDC+)	N/A	upper limit switch	common	retract (VDC+)	lower limit switch

Connector

1 = DIN 6P, 90° plug

2 = Tinned leads

4 = Big 01P, plug

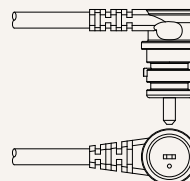
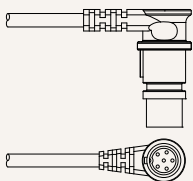

C = Y cable (direct cut, water proof, anti-pull)

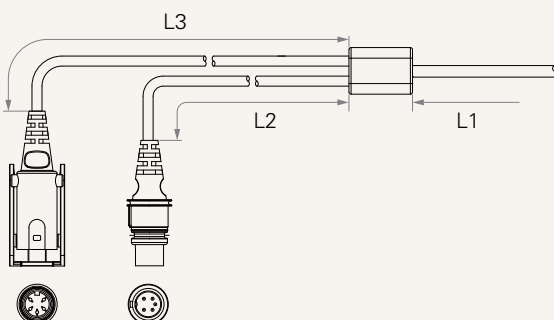

Cable Length for Direct Cut System (mm)

CODE	L1	L2	L3
B	100	100	100
C	100	1000	400
D	100	2700	500
E	1000	100	100
F	100	600	1000
G	1500	1000	1000
H	100	100	1200

Connector

D = Extension cable, not preset on motor cover (cable length 120mm)

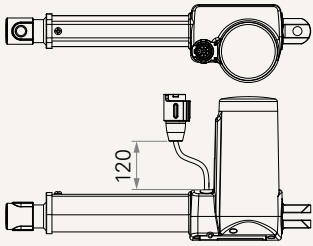

R = Extension cable, preset on motor cover (cable length 50mm)

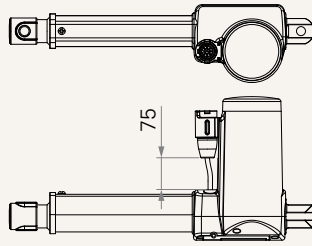

E = Molex 8P, plug

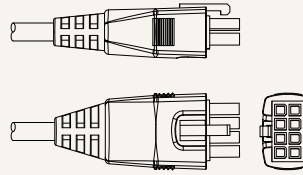

F = DIN 6P, 180° plug

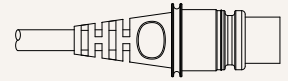

G = Audio plug



Q = Molex 6P, 90° plug

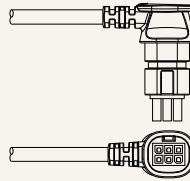

Terms of Use

The user is responsible for determining the suitability of TiMOTION products for a specific application. TiMOTION products are subject to change without prior notice.