

# TL24

series

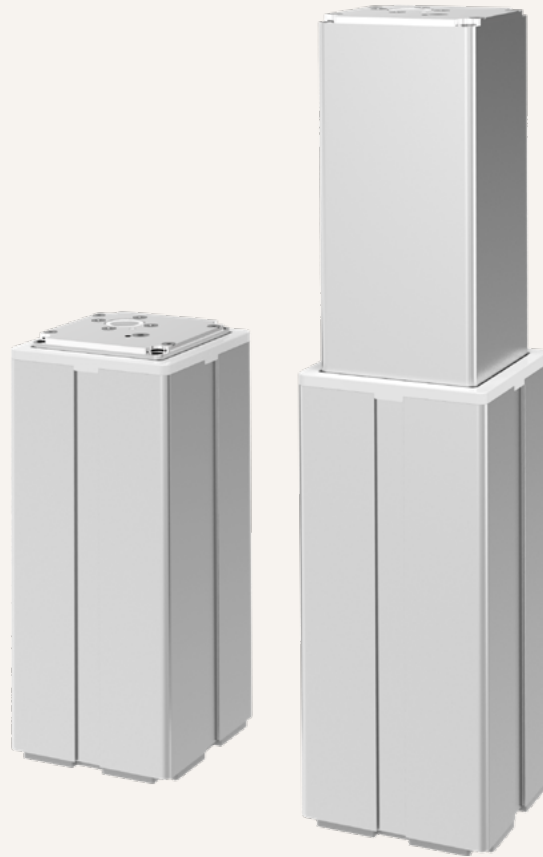

## Product Segments

- **Care Motion**
- **Ergo Motion**

TL24 electric lifting column is designed for medical applications such as height adjustable workstations, screens and optical machines. TL24 provides multiple cable exit options, such as from top end socket or top/bottom sides; besides, TL24 also support "direct cut system" which can be operated without control box, connecting the main power and hand control directly. The TL24 features an extruded aluminum rectangular 2 stage appearance.

### General Features

Max. load	3,300N (push)
Max. dynamic bending moment	200Nm
Max. static bending moment	400Nm
Max. speed at max. load	6.5mm/s
Max. speed at no load	38mm/s
Retracted length	≥ Stroke+188mm
IP rating	IPX6
Dimension of outer tube	110*110mm square
Stages	2-stage
Stroke	100~600mm
Output signals	Hall sensors, POT
Voltage	12/24V DC

**Drawing**

Standard Dimensions  
(mm)

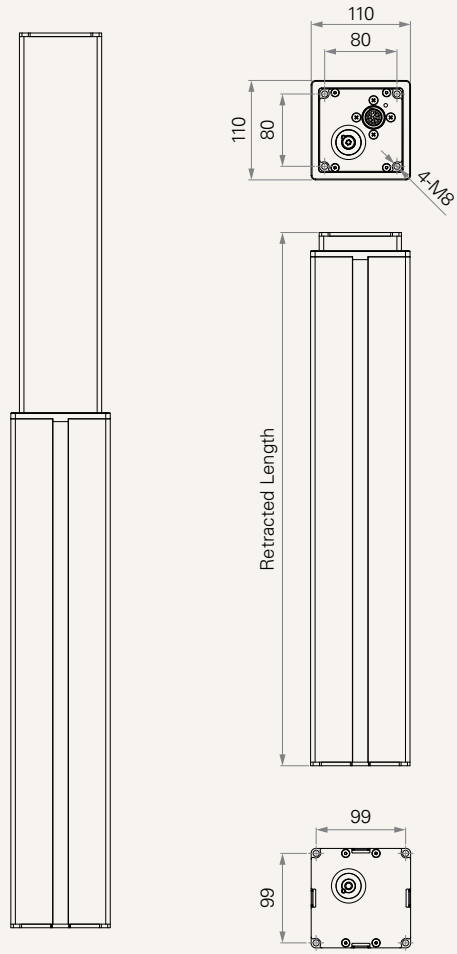

### Load and Speed

CODE	Load (N)	Self Locking Force (N)	Typical Current (A)		Typical Speed (mm/s)	
	Push		No Load 32V DC	With Load 24V DC	No Load 32V DC	With Load 24V DC
<b>4129 Motor Speed (5600RPM, Duty Cycle 10%)</b>						
<b>G</b>	3300	3300	2.0	4.7	12.0	6.5
<b>J</b>	1800	1800	2.0	3.2	17.0	10.5
<b>L</b>	800	800	2.5	5.0	38.0	22.0

### Note

- Parameters above are from tested average, please refer to approval drawing for final value.
- The current & speed in table are tested with 24V DC motor. With a 12V DC motor, the current is approximately twice the current measured in 24V DC; speed will be similar for both voltages.
- This self-locking force level is reached only when a short circuit is applied on the terminals of the motor. All the TiMOTION control boxes have this feature built-in.
- Operational temperature range: +5°C~+45°C
- Standard stroke: Please refer to below table

CODE	Load (N)	Min. Stroke (mm)	Max. Stroke (mm)
	Push		
<b>G</b>	3300	100	≤300
<b>J</b>	1800	100	≤450
<b>L</b>	800	100	≤600

### 6 Dynamic bending moment (Nm) - X direction

Stroke (mm)	Retracted Length (mm)
	S+188
<b>100-400</b>	200
<b>401-600</b>	200
<b>601-800</b>	200

- \* Bending moment Y direction= X
- \* Static bending moment= dynamic\*2

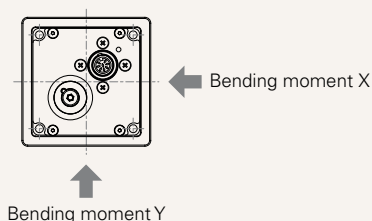

Performance Data (24V DC Motor)

4129 Motor Speed (5600RPM, Duty Cycle 10%)

Speed vs. Load

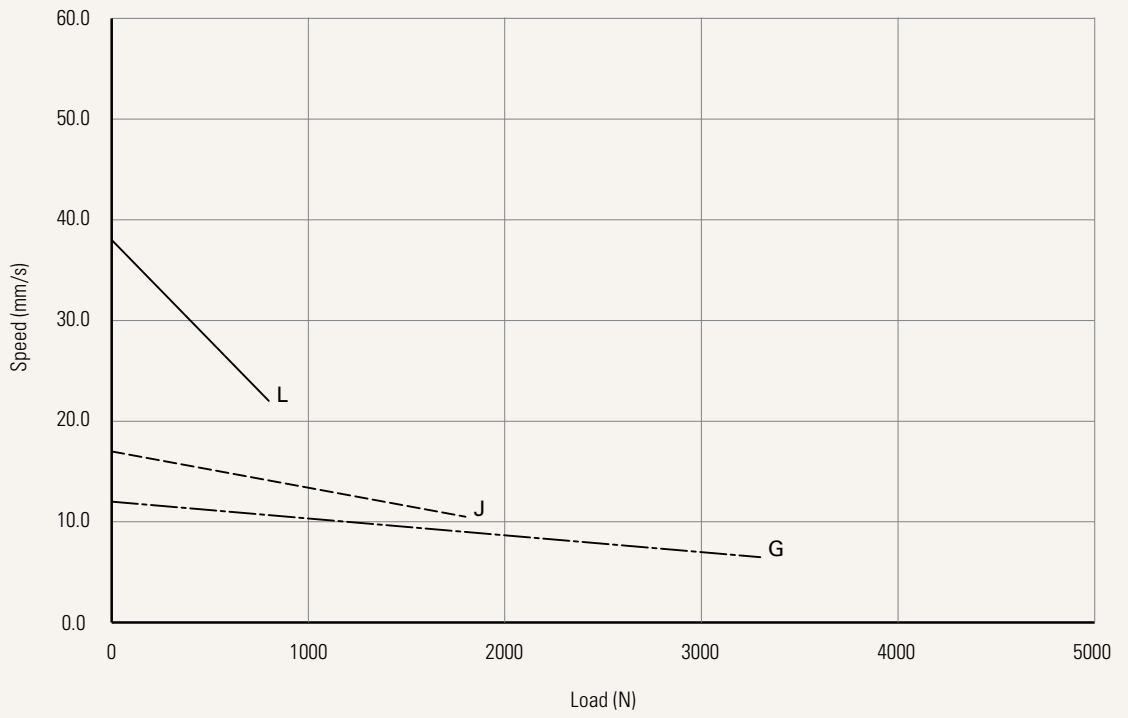

Current vs. Load

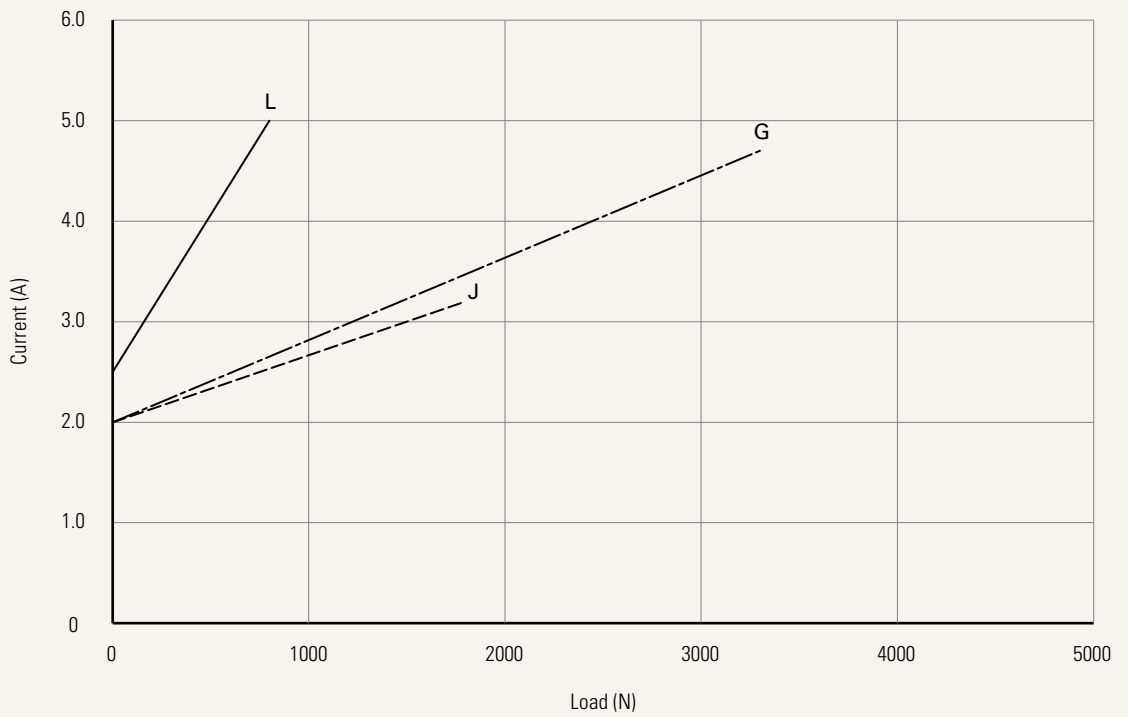

# TL24 Top End Socket Ordering Key

TL24

Version: 20240604-J

<b>Voltage</b>	1 = 12V DC	2 = 24V DC	
<b>Load and Speed</b>	<a href="#">See page 3</a>		
<b>Stroke (mm)</b>	<a href="#">See page 3</a>		
<b>Retracted Length (mm)</b>	<a href="#">See page 8</a>		
<b>Cable Exit</b> <a href="#">See page 9</a>	1 = Top end socket		
<b>Special Functions for Spindle Sub-Assembly</b>	0 = Without (Standard)	1 = Safety nut	
<b>Functions for Limit Switches</b> <a href="#">See page 9</a>	1 = Two switches at full retracted / extended positions to cut current 3 = Two switches at full retracted / extended positions to send signal		
<b>IP Rating</b>	1 = Without	2 = IPX4	3 = IPX6
<b>Output Signals</b>	0 = Without	2 = Hall sensor * 2	3 = POT
<b>Connector</b> <a href="#">See page 10</a>	1 = DIN 6P, socket		
<b>Color</b>	1 = Black	2 = Matte silver	
<b>Tubes Direction</b> <a href="#">See page 11</a>	0 = Thinner on top	1 = Wider on top	
<b>Top Plate</b> <a href="#">See page 11</a>	1 = Small plate		
<b>Bottom Plate</b> <a href="#">See page 11</a>	1 = Small plate		
<b>Grounding Function</b>	0 = Without		

## Note

<sup>1</sup> The TL24 is designed especially for push applications, not suitable for pull applications.

# TL24 Side Cable Ordering Key

TL24

Version: 20240604-J

<b>Voltage</b>	1 = 12V DC	2 = 24V DC		
<b>Load and Speed</b>	<a href="#">See page 3</a>			
<b>Stroke (mm)</b>	<a href="#">See page 3</a>			
<b>Retracted Length (mm)</b>	<a href="#">See page 8</a>			
<b>Cable Exit</b>	2 = Bottom side cable	3 = Top side cable		
	<a href="#">See page 9</a>			
<b>Special Functions for Spindle Sub-Assembly</b>	0 = Without (Standard)	1 = Safety nut		
<b>Functions for Limit Switches</b>	1 = Two switches at full retracted / extended positions to cut current			
	3 = Two switches at full retracted / extended positions to send signal			
	<a href="#">See page 9</a>			
<b>IP Rating</b>	1 = Without	2 = IPX4	3 = IPX6	
<b>Output Signals</b>	0 = Without	2 = Hall sensor * 2	3 = POT	
<b>Connector</b>	1 = DIN 6P, 90° plug	2 = Tinned leads	3 = Molex 6P, 90° plug	F = DIN 6P, 180° plug
	<a href="#">See page 10</a>			
<b>Cable Length (mm)</b>	1 = Straight, 500	3 = Straight, 1000	5 = Straight, 1500	7 = Straight, 2000
<b>Color</b>	1 = Black (Black cable set)		3 = Matte silver (Black cable set)	
	2 = Matte silver (428C color cable set)		4 = Black (428C color cable set)	
<b>Tubes Direction</b>	0 = Thinner on top	1 = Wider on top		
	<a href="#">See page 11</a>			
<b>Top Plate</b>	1 = Small plate			
	<a href="#">See page 11</a>			
<b>Bottom Plate</b>	1 = Small plate			
	<a href="#">See page 11</a>			
<b>Grounding Function</b>	0 = Without			

## Note

**1** The TL24 is designed especially for push applications, not suitable for pull applications.

<b>Voltage</b>	1 = 12V DC	2 = 24V DC
<b>Load and Speed</b>	<a href="#">See page 3</a>	
<b>Stroke (mm)</b>	<a href="#">See page 3</a>	
<b>Retracted Length (mm)</b>	<a href="#">See page 8</a>	
<b>Cable Exit</b> <a href="#">See page 8</a>	B = Top side- for TH; Bottom side- for TP C = Bottom side- Y cable, for TH + TP D = Top side- for the 2nd column; Bottom side- for TH & TP; direct cut operation with 2 columns E = Top side- for the 2nd column & TH; Bottom side- for TP; direct cut operation with 2 columns	
<b>Special Functions for Spindle Sub-Assembly</b>	0 = Without (Standard)	1 = Safety nut
<b>Functions for Limit Switches</b> <a href="#">See page 9</a>	1 = Two switches at full retracted / extended positions to cut current	
<b>IP Rating</b>	1 = Without	2 = IPX4      3 = IPX6
<b>Output Signals</b>	0 = Without	
<b>Connector</b> <a href="#">See page 10</a>	C = Direct cut, water proof, anti-pull	
<b>Cable Length (mm)</b> <a href="#">See page 10</a>	B = Cable exit #B, L2=L3=100 C = Cable exit #C, L1=L2=L3=100	D = Cable exit #D, L2=L3=L4=100 E = Cable exit #E, L2=L3=L4=100
<b>Color</b>	1 = Black (Black cable set) 2 = Matte silver (428C color cable set)	3 = Matte silver (Black cable set) 4 = Black (428C color cable set)
<b>Tubes Direction</b> <a href="#">See page 11</a>	0 = Thinner on top	1 = Wider on top
<b>Top Plate</b> <a href="#">See page 11</a>	1 = Small plate	
<b>Bottom Plate</b> <a href="#">See page 11</a>	1 = Small plate	
<b>Grounding Function</b>	0 = Without	

## Note

1 The TL24 is designed especially for push applications, not suitable for pull applications.

## Retracted Length (mm)

1. Minimum retracted length needs to  $\geq A+B+C$

### A.

Load (N)	800	1800	3300
	S+188	S+188	S+188

\* Different retracted length is relative to different bending moment, [See page 3.](#)

### B.

Cable Exit	Top End Socket	Bottom Side Cable	Top Side Cable	Direct Cut
	1	2	3	B, D, E C
	-	-	+15	+35 -

### C. When with POT (When without POT, C=0)

Cable Exit	Top End Socket	Bottom Side Cable	Top Side Cable
	1	2	3
	+36	+36	+36



## Cable Exit

1 = Top end socket

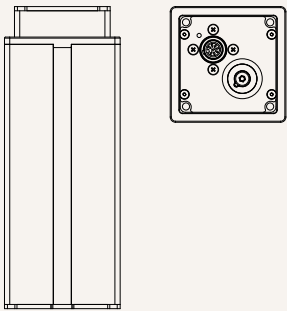

2 = Bottom side cable

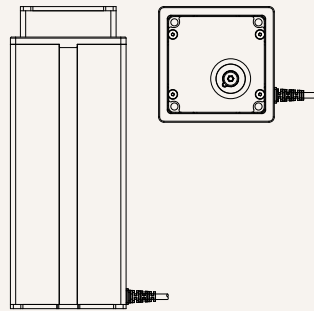

3 = Top side cable

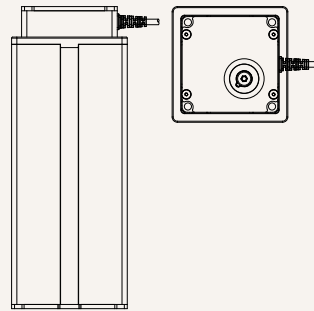

B = Top side- for TH; Bottom side- for TP

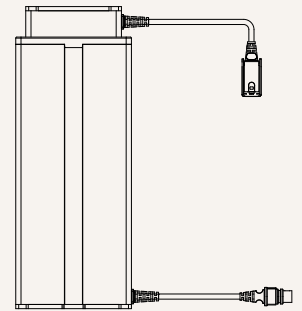

C = Bottom side- Y cable, for TH + TP

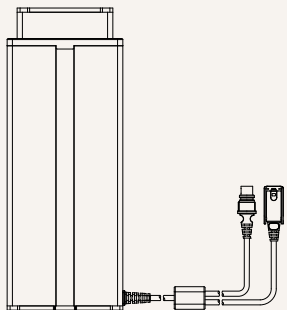

D = Top side- for the 2nd column;  
Bottom side- for TH & TP; direct cut operation with 2 columns

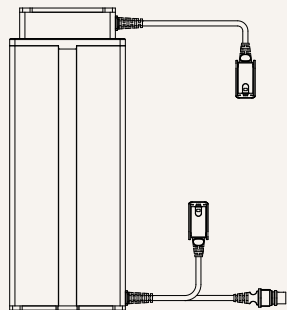

E = Top side- for the 2nd column & TH;  
Bottom side- for TP; direct cut operation with 2 columns

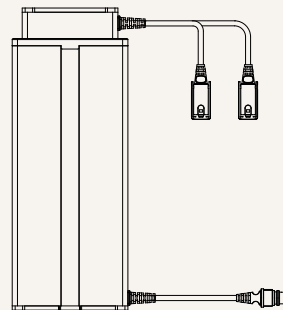

## Functions for Limit Switches

### Wire Definitions

CODE	Pin					
	1 (Green)	2 (Red)	3 (White)	4 (Black)	5 (Yellow)	6 (Blue)
1	extend (VDC+)	N/A	N/A	N/A	retract (VDC+)	N/A
3	extend (VDC+)	common	upper limit switch	N/A	retract (VDC+)	lower limit switch

## Connector (Top End Socket)

1 = DIN 6P, socket

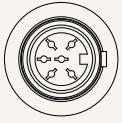

## Connector (Side Cable)

1 = DIN 6P, 90° plug

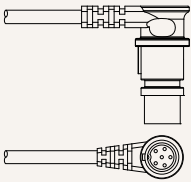

2 = Tinned leads

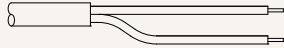

3 = Molex 6P, 90° plug

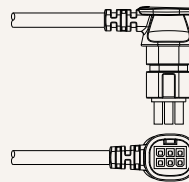

F = DIN 6P, 180° plug



## Connector (Direct Cut)

C = Direct cut, water proof, anti-pull

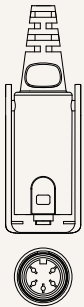

For TH:  
long DIN 5P (Pin array 240°),  
180° socket (with anti-pull clip)



For TP:  
long DIN 5P (Pin array 240°),  
180° plug (with O-ring)

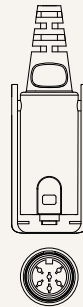

For Column 2:  
long DIN 6P (Pin array 240°),  
180° plug (with anti-pull clip)

## Cable Length (mm)

B = Cable exit #B, L2=L3=100

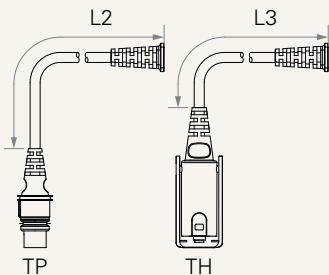

C = Cable exit #C, L1=L2=L3=100

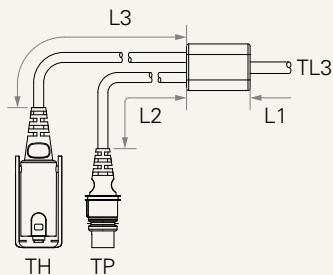

D = Cable exit #D, L2=L3=L4=100

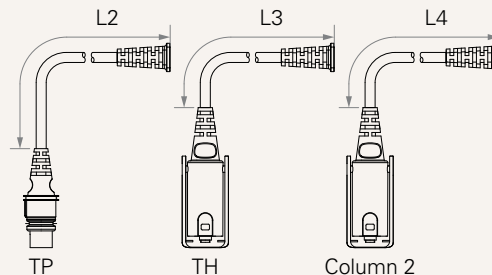

E = Cable exit #E, L2=L3=L4=100

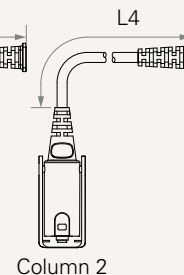

## Tubes Direction

0 = Thinner on top

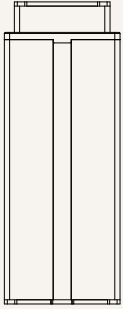

1 = Wider on top

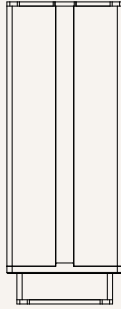

## Top Plate

1 = Small plate (Top end socket)

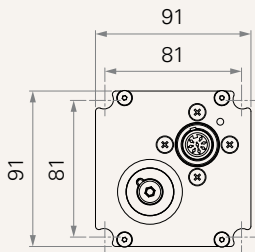

1 = Small plate (Side cable)

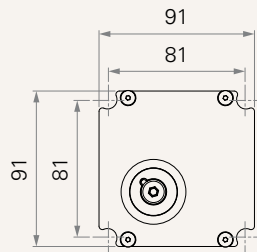

## Bottom Plate

1 = Small plate

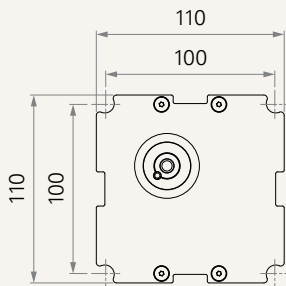

## Terms of Use

The user is responsible for determining the suitability of TiMOTION products for a specific application. TiMOTION products are subject to change without prior notice.