

TA16

series



Product Segments

- **Care Motion**
- **Comfort Motion**
- **Ergo Motion**
- **Industrial Motion**

TiMOTION's TA16 series linear actuator is similar to the TA2 linear actuator, but is specifically designed for low-noise applications where a compact linear actuator is needed. It is available with optional IP66 protection and Hall sensors for position feedback. Certificates for the TA16 include IEC60601-1, ES60601-1, IEC60601-1-2, UL962, and EMC.

General Features

Max. load	4,500N (push) ; 2,500N (pull)
Max. speed at max. load	4.9mm/s
Max. speed at no load	56.5mm/s
Retracted length	≥ Stroke + 112mm
IP rating	IP66M
Certificate	IEC60601-1, ES60601-1, IEC60601-1-2, UL962, EMC
Stroke	20~600mm
Output Signals	Pot., NPN Hall sensors
Options	Motor brake
Voltage	12/24/36/48V DC; 12/24/48V DC (PTC)
Color	Silver
Operational temperature range at full performance	+5°C~+45°C
With very low noise, small size for easy installation	
Suitable for patient hoist application	

Drawing

Dimensions
without Output Signal
or with Hall Sensors
(mm)

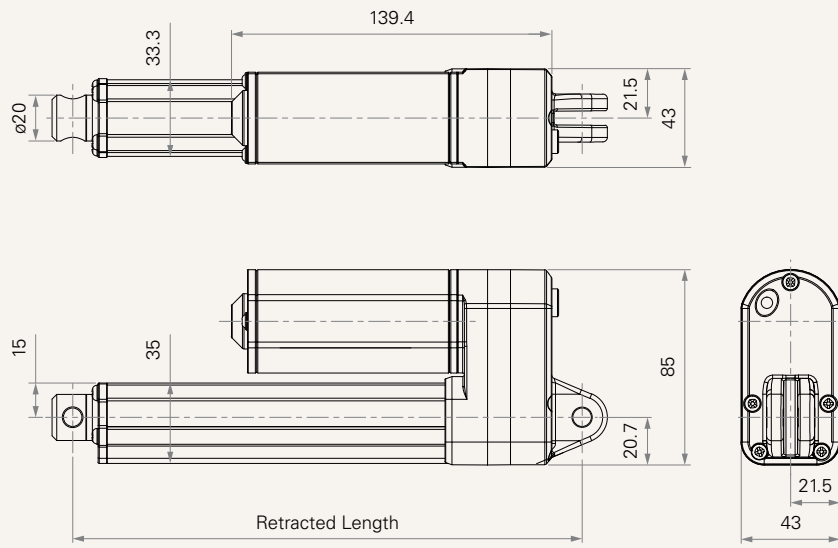

Dimensions with POT
(mm)

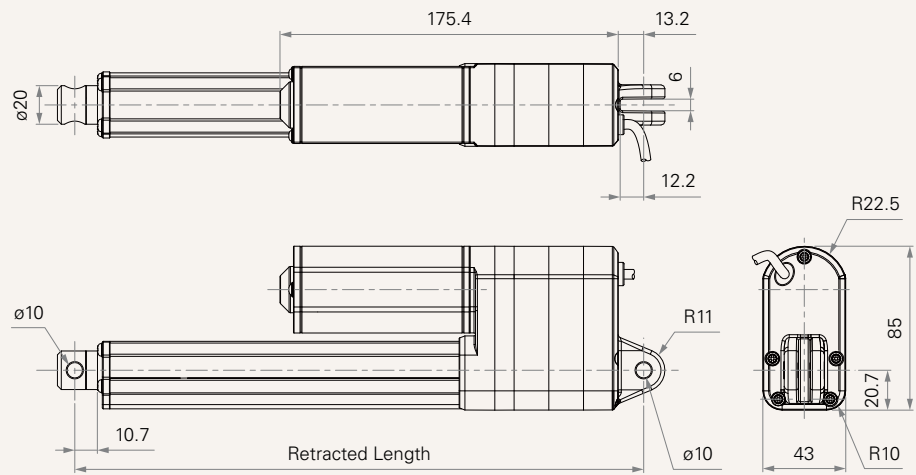

Load and Speed

CODE	Load (N)		Self Locking Force (N)	Typical Current (A)		Typical Speed (mm/s)	
	Push	Pull		No Load 32V DC	With Load 24V DC	No Load 32V DC	With Load 24V DC
Motor Speed (3800RPM, Duty Cycle 10%)							
A	2500	2500	2500	1.7	2.4	5.2	3.0
B	2000	2000	2000	1.7	2.4	8.3	4.7
C	1500	1500	1500	1.7	2.2	10.8	7.0
D	1000	1000	1000	1.7	2.4	17.1	10.0
E	500	500	500	1.7	2.8	56.5	28.0
Motor Speed (5200RPM, Duty Cycle 10%)							
G	3500	2500	3500	2.0	4.7	11.0	6.2
J	2000	2000	2000	2.0	3.7	15.8	9.5
K	1500	1500	1500	2.0	3.7	21.5	14.2
L	4500	2500	4500	2.0	5.0	9.5	4.9

Note

- 1 #G_When pull load > 2500N, please discuss with engineer.
- 2 Please refer to the approved drawing for the final authentic value.
- 3 This self-locking force level is reached only when a short circuit is applied on the terminals of the motor. All the TiMOTION control boxes have this feature built-in. The self-locking force is a minimum value and can be actually higher.
- 4 The current & speed in table are tested with 24V DC motor. With a 12V DC motor, the current is approximately twice the current measured in 24V DC. With a 36V DC motor, the current is approximately two-thirds the current measured in 24V DC. With a 48V DC motor, the current is approximately half the current measured in 24V DC. Speed will be similar for all the voltages.
- 5 The current & speed in table is tested when the actuator is extending under push load
- 6 The current & speed in table and diagram are tested with TiMOTION control boxes, and there will be around 10% tolerance depending on different models of the control box. (Under no load condition, the voltage is around 32V DC. At rated load, the voltage output will be around 24V DC)
- 7 Without load, noise level ≤ 56dBA (by TiMOTION test standard, ambient noise level ≤ 36dBA).
- 8 Standard stroke: Please refer to the table below.

CODE	Load (N)	Min Stroke (mm)	Max Stroke (mm)
E	≤ 500	38	600
D	≤ 1000	20	600
C, K	≤ 1500	20	500
B, J	≤ 2000	20	450
A	≤ 2500	20	400
G	≤ 3500	20	300
L	≤ 4500	20	300

Performance Data (24V DC Motor)

Motor Speed (3800RPM, Duty Cycle 10%)

Speed vs. Load

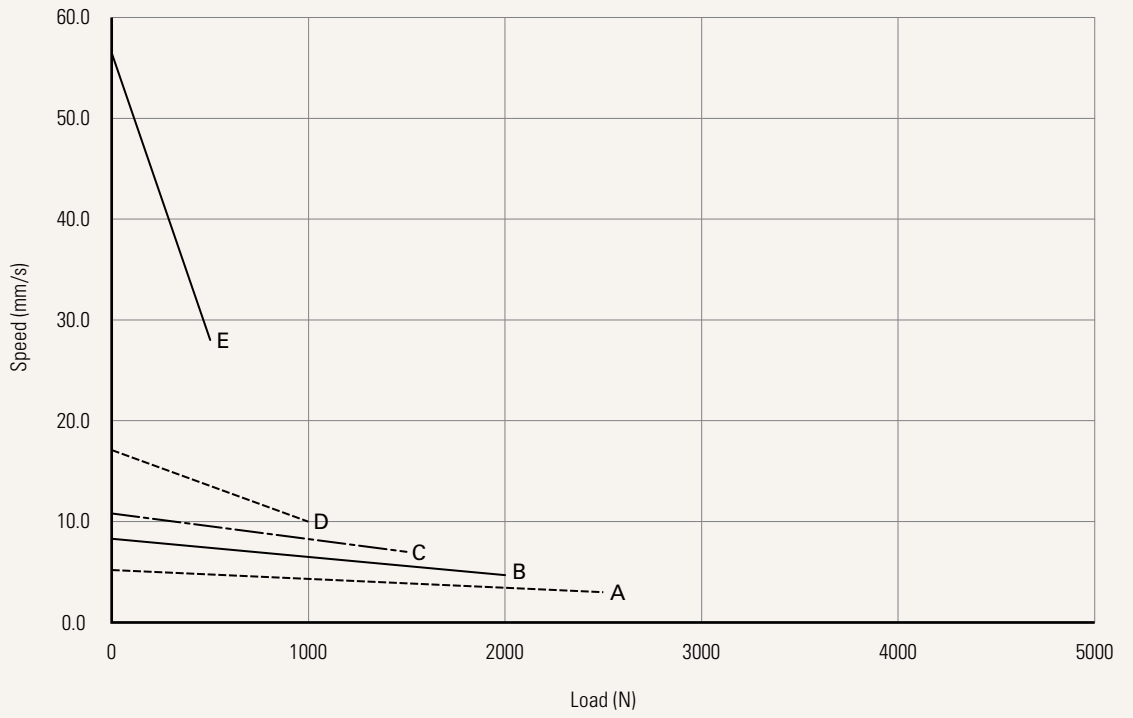

Current vs. Load

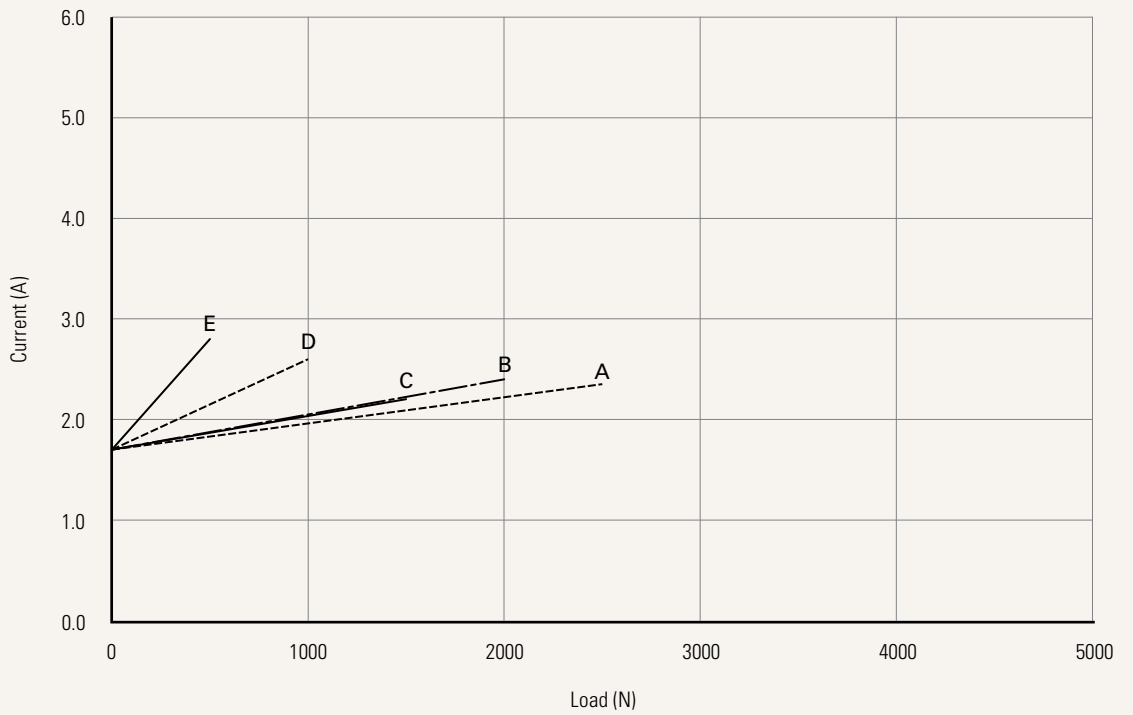

Performance Data (24V DC Motor)

Motor Speed (5200RPM, Duty Cycle 10%)

Speed vs. Load

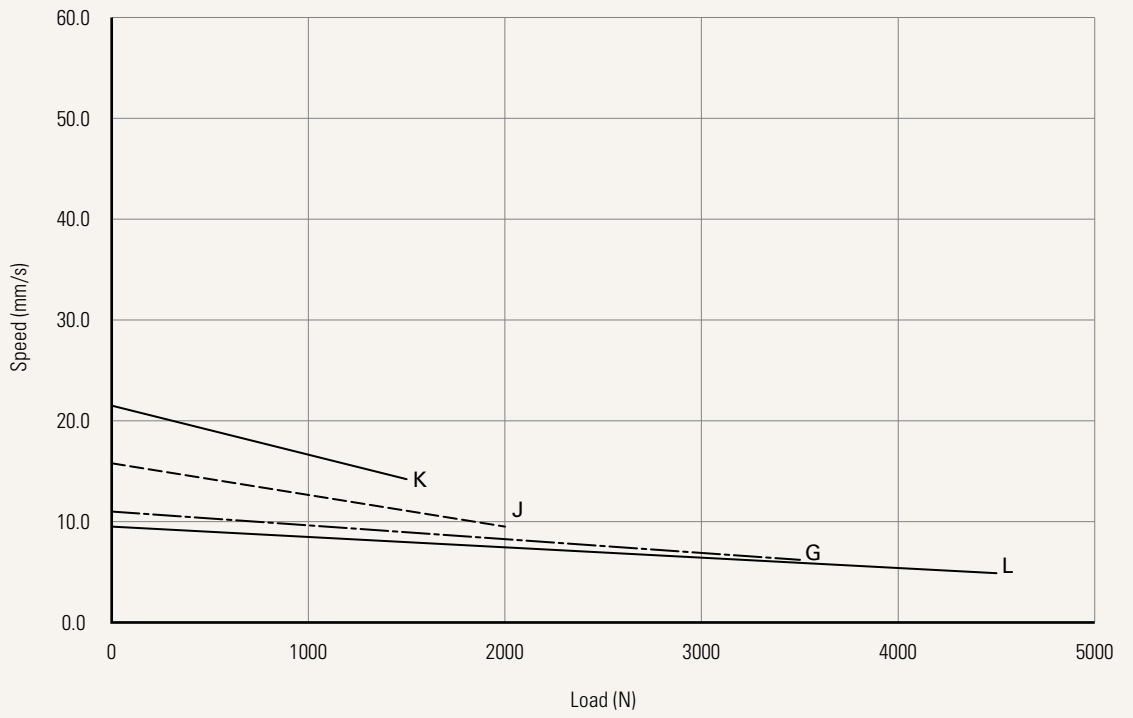

Current vs. Load

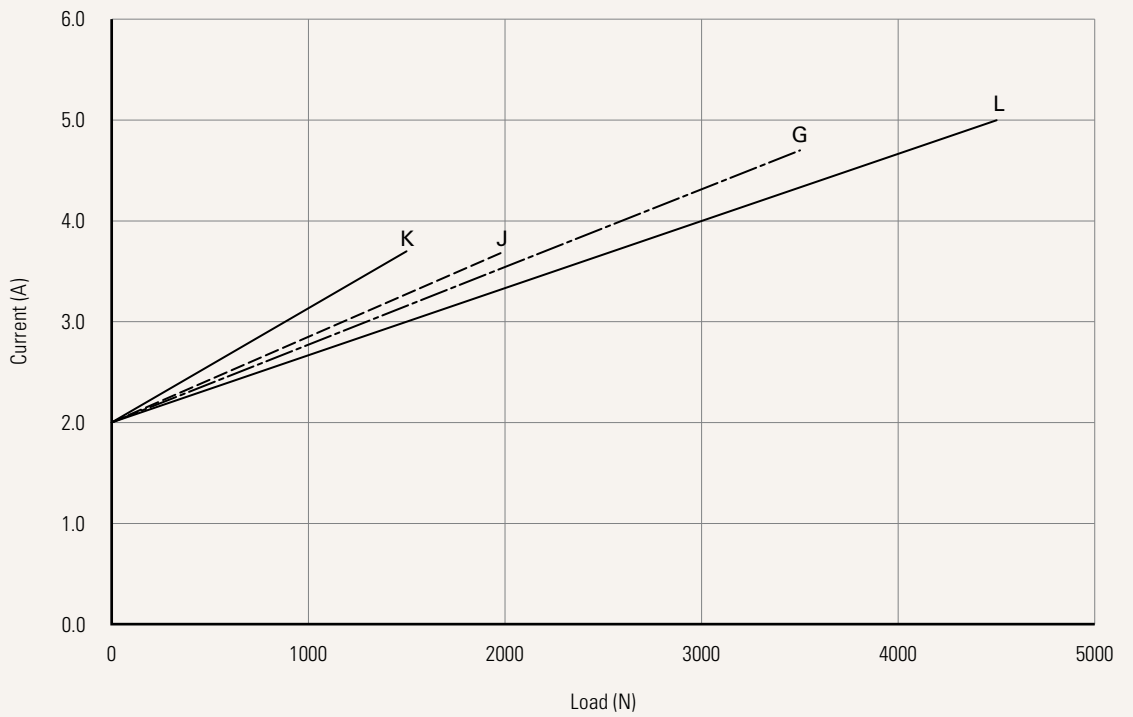

Voltage	1 = 12V DC 2 = 24V DC	3 = 36V DC 4 = 48V DC	5 = 24V DC, PTC 6 = 12V DC, PTC	8 = 48V DC, PTC
Load and Speed	See page 3			
Stroke (mm)	See page 3			
Retracted Length (mm)	See page 7			
Rear Attachment (mm) See page 8	1 = Aluminum, U clevis, width 6.0, depth 12.2, hole 6.4, one piece casting with gearbox 2 = Aluminum, U clevis, width 6.0, depth 12.2, hole 8.0, one piece casting with gearbox 3 = Aluminum, U clevis, width 6.0, depth 12.2, hole 10.0, one piece casting with gearbox B = Aluminum, U clevis, width 6.0, depth 12.2, hole 10.2, one piece casting with gearbox, with plastic T-bushing (black), for weather resistant application			
Front Attachment (mm) See page 8	1 = Aluminum, slotless, hole 6.4 2 = Aluminum, slotless, hole 8.0 3 = Aluminum, slotless, hole 10.0 4 = Aluminum, U clevis, width 6.0, depth 13.0, hole 6.4 5 = Aluminum, U clevis, width 6.0, depth 13.0, hole 8.0	6 = Aluminum, U clevis, width 6.0, depth 13.0, hole 10.0 B = Aluminum, slotless, hole 10.2, with plastic T-bushing (black), for weather resistant application C = Steel, U clevis, width 6.0, depth 13.0, hole 10.2, with plastic T-bushing (black), for weather resistant application		
Direction of Rear Attachment (Counterclockwise) See page 9	1 = 90°	2 = 0°		
IP Rating	1 = Without 2 = IP54	3 = IP66 5 = IP66W	6 = IP66M	
Function of Limit Switches See page 9	1 = Two micro switches cut off the actuator at end of stroke 2 = Two micro switches cut off the actuator at end of stroke + third one in between sends signal 3 = Two micro switches send signal at end of stroke 4 = Two micro switches send signal at end of stroke + third one in middle sends signal			
Special Function of Spindle Set	0 = Without (Standard) 1 = Safety nut	2 = Standard push only 3 = Standard push only + safety nut		
Output Signal	0 = Without 1 = Pot.	N = NPN Hall sensor * 2		
Connector See page 9-10	1 = DIN 6P, 90° plug 2 = Tinned leads 4 = Big 01P, plug	C = Y cable (For direct cut system, water proof, anti pull) E = Molex 8P, plug F = DIN 6P, 180° plug	G = Audio plug	
Cable Length (mm)	0 = Straight, 100 1 = Straight, 500 2 = Straight, 750	3 = Straight, 1000 4 = Straight, 1250 5 = Straight, 1500	6 = Straight, 2000 7 = Curly, 200 8 = Curly, 400	B-H = For direct cut system See page 9
Brake	0 = Without	1 = Motor brake		
Load Type	T = Push	P = Pull		
Color	0 = Silver grey 3 = Glittering black, for weather resistant application			

Retracted Length (mm)

1. Calculate $A+B+C+D+E = Y$
2. Retracted length needs to \geq Stroke + Y

A. Rear / Front Attach.

Front Attach.	Rear Attach.
	1, 2, 3, B
1, 2, 3	+112
B	+115
4, 5, 6, C	+122

B. Load V.S. Stroke

Stroke (mm)	Load & Speed Type	
	A, B, C, D, E, J, K	G, L
20~150	-	+13
151~200	+8	+21
201~250	+8	+21
251~300	+13	+26
301~350	+13	+26
351~400	+18	+31
401~450	+23	+36
451~500	+28	+41
501~550	+33	+46
551~600	+38	+51

C. Load V.S. Spindle Functions

Spindle Functions	Load & Speed Type	
	A, B, C, D, E, J, K	G, L
0	-	-
1	+10	+5
2	+2	+2
3	+12	+7

D. Output Signals

0, 4, 5	-
1	+36

E. IP Rating

1, 2, 3, 5	-
6	+5

Rear Attachment (mm)

1 = Aluminum, U clevis, width 6.0, depth 12.2, hole 6.4, one piece casting with gearbox

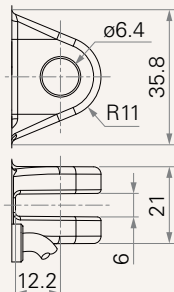

2 = Aluminum, U clevis, width 6.0, depth 12.2, hole 8.0, one piece casting with gearbox

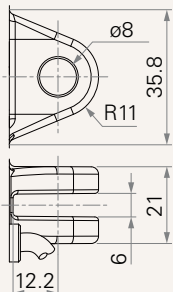

3 = Aluminum, U clevis, width 6.0, depth 12.2, hole 10.0, one piece casting with gearbox

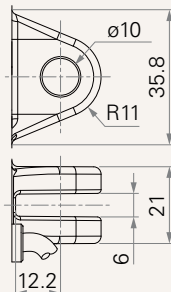

B = Aluminum, U clevis, width 6.0, depth 12.2, hole 10.2, one piece casting with gearbox, with plastic T-bushing (black), for weather resistant application

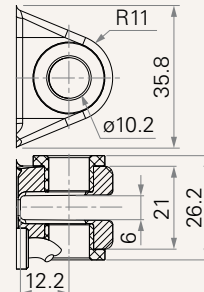

Front Attachment (mm)

1 = Aluminum, slotless, hole 6.4

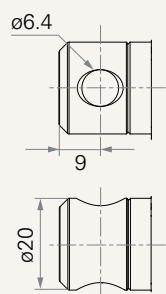

2 = Aluminum, slotless, hole 8.0

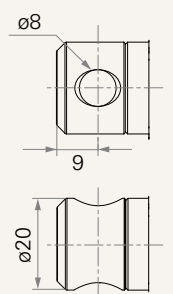

3 = Aluminum, slotless, hole 10.0

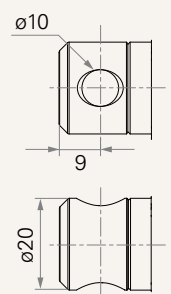

4 = Aluminum, U clevis, width 6.0, depth 13.0, hole 6.4

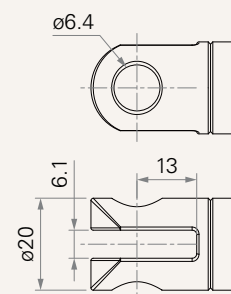

5 = Aluminum, U clevis, width 6.0, depth 13.0, hole 8.0

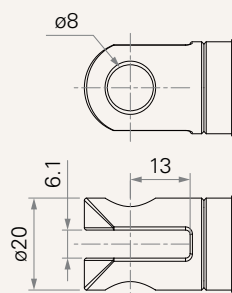

6 = Aluminum, U clevis, width 6.0, depth 13.0, hole 10.0

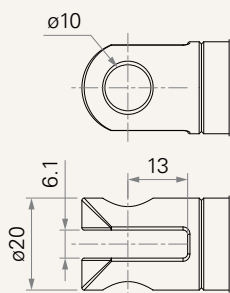

B = Aluminum, slotless, hole 10.2, with plastic T-bushing (black), for weather resistant application

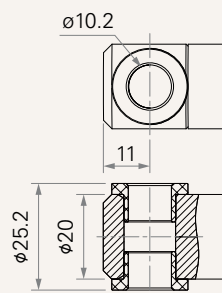

C = Steel, U clevis, width 6.0, depth 13.0, hole 10.2, with plastic T-bushing (black), for weather resistant application

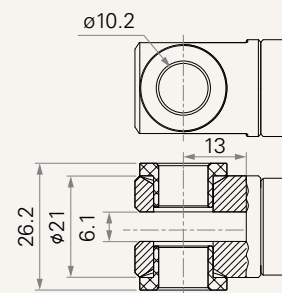

Direction of Rear Attachment (Counterclockwise)

1 = 90°

2 = 0°

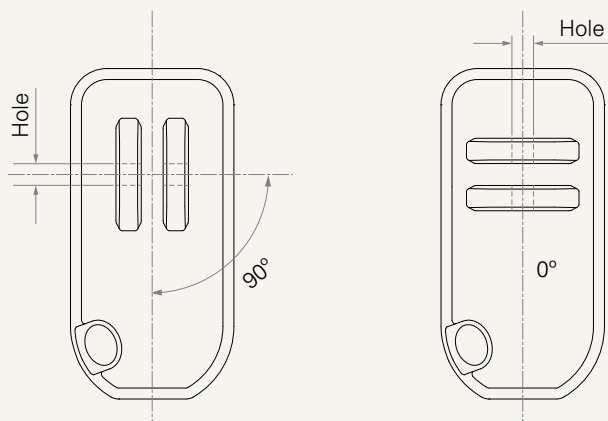

Function of Limit Switches

Wire Definitions

CODE	Pin					
	● 1 (Green)	● 2 (Red)	○ 3 (White)	● 4 (Black)	● 5 (Yellow)	● 6 (Blue)
1	extend (VDC+)	N/A	N/A	N/A	retract (VDC+)	N/A
2	extend (VDC+)	N/A	middle switch pin B	middle switch pin A	retract (VDC+)	N/A
3	extend (VDC+)	common	upper limit switch	N/A	retract (VDC+)	lower limit switch
4	extend (VDC+)	common	upper limit switch	medium limit switch	retract (VDC+)	lower limit switch

Connector

1 = DIN 6P, 90° plug

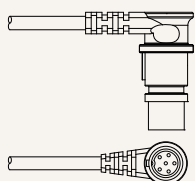

2 = Tinned leads

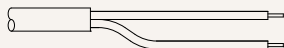

4 = Big 01P, plug

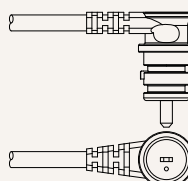

C = Y cable (For direct cut system, water proof, anti pull)

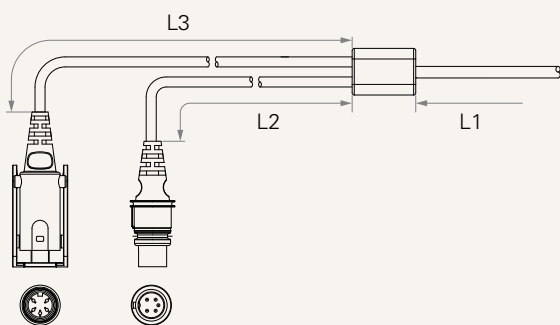

Cable Length for Direct Cut System (mm)

CODE	L1	L2	L3
B	100	100	100
C	100	1000	400
D	100	2700	500
E	1000	100	100
F	100	600	1000
G	1500	1000	1000
H	100	100	1200

Connector

E = Molex 8P, plug

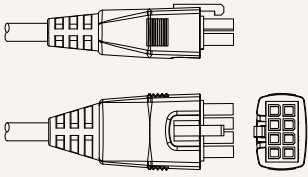

F = DIN 6P, 180° plug

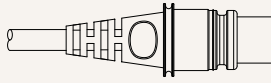

G = Audio plug

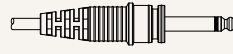

Terms of Use

The user is responsible for determining the suitability of TiMOTION products for a specific application. TiMOTION products are subject to change without prior notice.